

Commercial Water Heating System (CR60-WH-2)

RACK SPECIFICATIONS WITH WATER HEATER MODEL NCC199CDV

Project Name _____

Prepared By _____

Project # _____

Rack Model _____

Location _____

Quantity (Racks) _____

Wholesaler _____

Gas Type NG LP

Contractor _____

Date _____

Notes /
Comments

NCC199CDV (GQ-C3260WZ-FF US)

Commercial Condensing Water Heater

Specification Sheet



Standard Input

18,000-199,900 BTU/h / 0.5 - 11.1gpm (NCC199CDV)

Uniform Energy Factor (UEF)

0.96 (NG) / 0.96 (LP)

Compact Design -

ANSI Z21.10.3/CSA 4.3 certified design that can be wall-mounted indoors or installed outdoors using the optional Vent Cap

Heat Exchanger -

Manufactured with high quality stainless steel

Venting Options -

Available in Direct Vent model that can use either 2" or 3" Schedule 40 PVC/CPVC or installed outdoors with Vent Cap.

Common Vent Compatible -

Vent up to 6 units on a single venting system with integrated backflow preventer.

Direct Electronic Ignition

Wifi Capable

Compatible with 1/2" gas pipe -

See installation manual

Multi-System Capability -

Units can be linked together by using either the optional 2-unit Quick Connect or multi-unit System Controller for up to 24 units

Fully Modulating -

BTU input range from 18,000 to 4.8 million BTU/h (with 24 unit System) with stable combustion provided by gas venturi and pre-mix burner. Each individual unit 11:1 Turndown Ratio

Temperature Controls -

Includes remote thermostat that can precisely adjust the output temperature from 100°F to 185°F

Safety Devices -

Flame Sensor, Overheat Prevention Device, Lightning Protection Device, Freeze Protection, Condensate Overflow

10 Year* Limited Heat Exchanger Warranty for Commercial Use

5 Year Limited Parts Warranty & 1 Year Reasonable Labor

Approvals -

CSA, UPC** , NSF, Low NOx Approved By SCAQMD (Rule 1146.2)

Accessories

- Universal Concentric Vent Kit (#PVC-UCVK)
- Low Profile Termination Kit (#PVC-LPT)
- PVC Concentric Termination (#PVC-CT)
- 3" Horizontal Hood Termination (#PVT-HL)
- SV Conversion (#SV-CK-2-1)
- Birdscreen (#VT-PVCS)
- Outdoor Vent Cap (#VC-6-1)
- Isolator Valves (#IK-WV-200)
- Pipe Cover (#PC-10S)
- Commercial Wireless Monitor (#NWCC-ADAPTER)
- Quick Connect Cord (#QC-2)
- System Controller: 6-Unit (#SC-401-6M)
- System Controller: 12-unit (#SCU-401-12M)
- System Controller: 24-unit (#SC-401-24M)
- Neutralizer for 1-unit (#NC-1S)
- Neutralizer for up to 16 unit (#NT-20A)



* Refer to the Noritz Limited Warranty for complete coverage details at Noritz.com

** This product complies with California AB 1953 Low Lead Law and section 1417(d) of the Safe Drinking Water Act

Dimensions

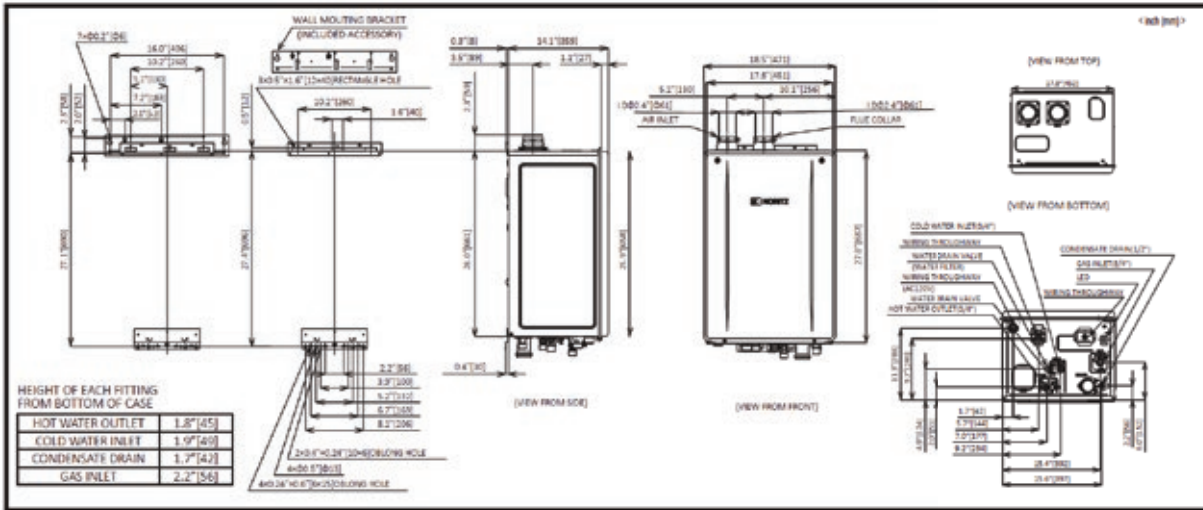

Flow Rate

Temperature Rise (°F)	30	40	45	50	60	70	80	90	100	110	120	130	140
NCC199CDV (GPM)	11.1	9.7	8.7	7.8	6.5	5.5	4.8	4.3	3.9	3.5	3.2	3.0	2.8

Pressure Drop

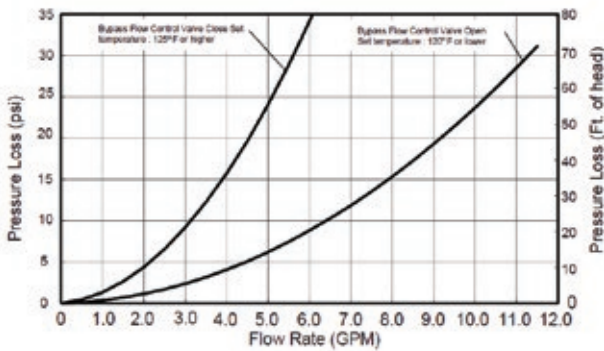

Specifications

Model Name		NCC199CDV (GQ-C3260WZ-FF US)
Weight		70 pounds
Operating Pressure		15 - 150 psi
Gas Supply Pressure		NG: 3.5" - 10.5" LP: 8.0" - 14.0"
Water Holding Capacity		0.80 Gallon (3.2L)
Connection Sizes	Water Inlet	3/4" NPT
	Hot Water Outlet	3/4" NPT
	Gas Inlet	3/4" NPT
	Condensate Drain	1/2" NPT
Power	Supply	120VAC (60Hz), less than 4 amperes
	Consumption	NG : 96W LP: 80W Freeze Protection: 114W
Freeze Protection		Outdoor: -4°F / Indoor: -30°F
Temperature Settings	°F Mode	100-150°F (In 5 °F in ervals), 160°F, 170°F, 185°F (14 Options)
	°C mode	37-48°C (In 1°C intervals), 50-85°C (In 5°C intervals) (20 Options)
Materials	Front Cover	Hot-dipped zinc-aluminum-magnesium-alloy-coated steel w/ polyester coating
	Casing	Zincified Steel Plate / Polyester Coating



CR60 Commercial Rack System

The Noritz Commercial Water Heating System (CR60-CA) is a pre-fabricated racking solution that can be used in flat rooftop, mechanical room, or outdoor applications. For the wall mounted configurations, Commercial Water Heating Systems are available in 2 or 3 Noritz tankless water heater configurations. The floor standing Commercial Water Heating Systems are available with 4, 5 or 6 unit Noritz tankless water heater configurations. For outdoor installation, vent caps (VC-6-1) must be ordered for each individual unit.



The CR60-CA provides a time and labor saving solution when installing multiple Noritz tankless water heaters.

Features And Benefits

- Indoor or outdoor compatible
- Manufactured with highly corrosion-resistant aluminum that can withstand extreme environments
- Cold and hot water lines as well as gas line are 2". Connect multiple racks together for easy scalability
- System controller (SC-401-6M) included and installed for controlling 6 units
- Remote controller display panel included for adjusting temperatures and monitoring system operation
- Condensate manifold included for easy connection and disposal.
- Service isolation valves with 150 PSI pressure relief installed on each unit for easy maintenance.
- Hoist rings provided for easy lifting (floor standing models only)
- Optional floor support (wall hanging models only) included for easy wall installation
- Common vent capable up to 6 units on a single exhaust system without the need for any additional accessories
- Integrated gas sediment traps on each unit
- Fuel gas manifold factory pressure tested at normal (0.5 psi) and high pressure (60 psi)
- Secondary gas shut-off to facilitate gas sediment trap servicing and field pressure testing

CR60-WH-2

Commercial Rack System

Commercial Water Heating System			
Model Number	Rack Type	Configuration	Illustration
CR60-WH-2-NG	2 Unit DV Wall Hanging, NG		
CR60-WH-2-LP	2 Unit DV Wall Hanging, LP		



System Shown

CR60-WH-2

CR60-WH-2

Specifications

BTU and Flow Rates for NCC199CDV (GQ-C3260WZ-FF-US)	
Number of Tankless Water Heaters	2
Max. Hot Water Capacity @ 30°F Rise (GPM)	22.2
Max. Hot Water Capacity @ 70° Rise (GPM)	11.2
Minimum (BTUh)	18,000
Maximum (BTUh)	399,800

Model and Rack Specifications	
Model Number	CR60-WH-2
Tankless Water Heater Model	NCC199CDV
Frame Dimensions (in.)	52.25" (L) x 17" (D) x 45" (H) (H: 78" with optional floor support)
Weight - Fully Assembled (lbs.)	259
Shipping Weight - Fully Assembled (lbs.)	429
Frame Material	Aluminum
Frame Color	Aluminum
Water & Gas Pipe Connections	
Hot Water Manifold Pipe Material	Copper
Cold Water Manifold Pipe Material	Copper
Gas Manifold Pipe Material	Black Iron
Condensate Drain Manifold Pipe Material	Schedule 40 PVC
Hot Water Manifold Pipe Diameter (in.)	2"
Cold Water Manifold Pipe Diameter (in.)	2"
Gas Manifold Pipe Diameter (in.)	2"
Condensate Drain Manifold Pipe Diameter (in.)	3/4"
Electrical Requirements	
Voltage	120VAC (60hz)
Maximum Current (Amps)	8

Tankless With Storage Hot Water Supply Capacity

Model	Qty Heaters	Max Input (BTU / HR)	Tank Recovery Circulator Size		UEF / TE	Recovery (GPH) @ Temperature Rise (Deg F)				
			GPM	Pressure Head (Ft.)		60°	70°	80°	90°	100°
CR60-WH-2-NG	2	399,800	12	21	96% / 98%	784	672	588	522	470
CR60-WH-2-LP										
CR60-WH-3-NG	3	599,700	18	21	96% / 98%	1,175	1,007	882	784	705
CR60-WH-3-LP										
CR60-FS-3-NG	3	599,700	18	21	96% / 98%	1,175	1,007	882	784	705
CR60-FS-3-LP										
CR60-FS-4-NG	4	799,600	24	21	96% / 98%	1,567	1,343	1,175	1,045	940
CR60-FS-4-LP										
CR60-FS-5-NG	5	999,500	30	21	96% / 98%	1,959	1,679	1,469	1,306	1,175
CR60-FS-5-LP										
CR60-FS-6-NG	6	1,199,400	36	21	96% / 98%	2,351	2,015	1,763	1,567	1,410
CR60-FS-6-LP										

Tankless Without Storage Hot Water Supply Capacity

Model	Qty Heaters	Max Input (BTU/Hr)	UEF / TE	Recovery (GPM) @ Temperature Rise (Deg F)				
				60°	70°	80°	90°	100°
CR60-WH-2-NG	2	399,800	96% / 98%	13.1	11.2	9.8	8.7	7.8
CR60-WH-2-LP								
CR60-WH-3-NG	3	599,700	96% / 98%	19.6	16.8	14.7	13.1	11.8
CR60-WH-3-LP								
CR60-FS-3-NG	3	599,700	96% / 98%	19.6	16.8	14.7	13.1	11.8
CR60-FS-3-LP								
CR60-FS-4-NG	4	799,600	96% / 98%	26.1	22.4	19.6	17.4	15.7
CR60-FS-4-LP								
CR60-FS-5-NG	5	999,500	96% / 98%	32.7	28	24.5	21.8	19.6
CR60-FS-5-LP								
CR60-FS-6-NG	6	1,199,400	96% / 98%	39.2	33.6	29.4	26.1	23.5
CR60-FS-6-LP								

CR60-WH-2

Dimensions

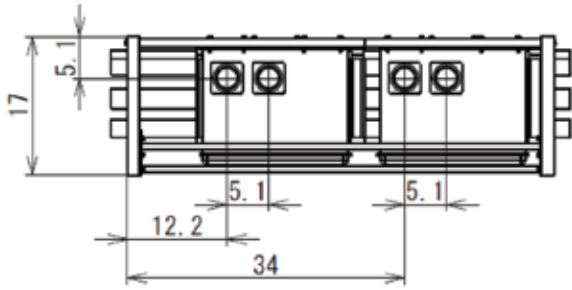

«Top»

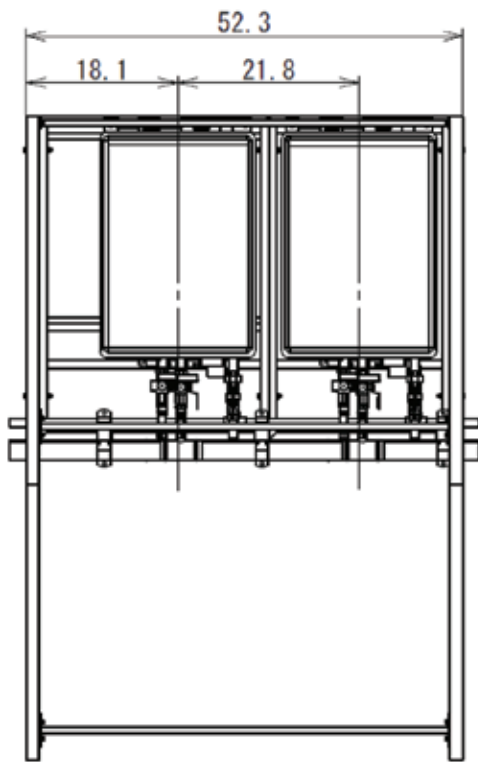
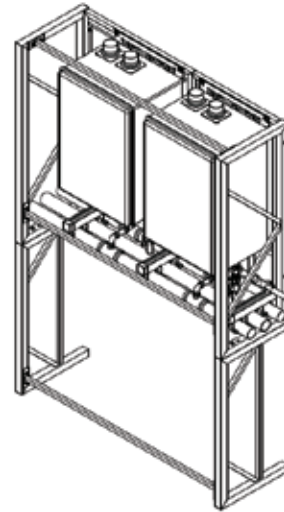

«Front»

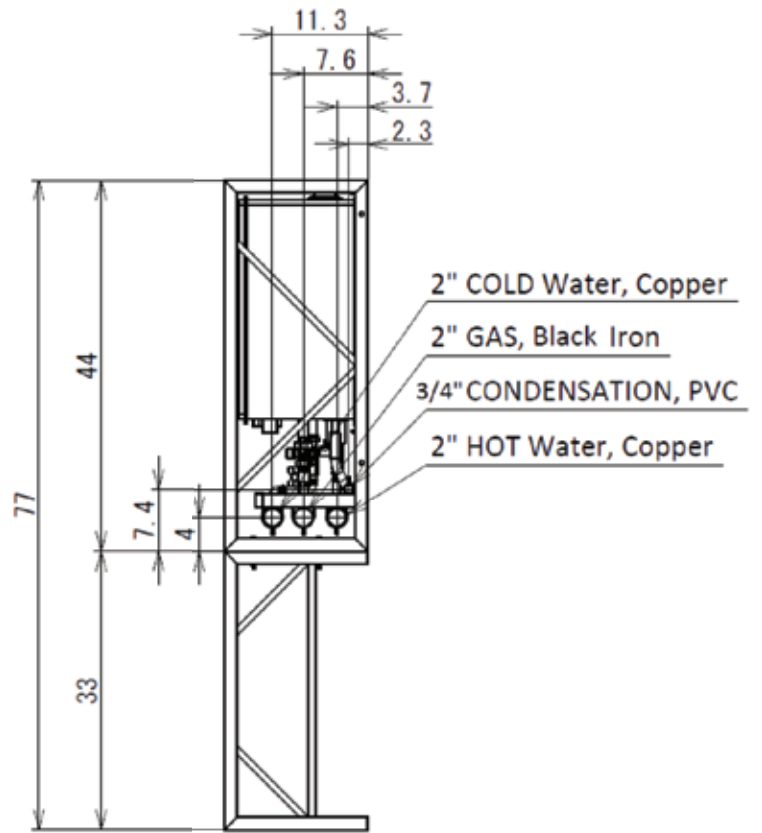

«Right»

*All units are in inches

Common Venting

Ultimate Flexibility For Vent Configuration

Figuring out where to safely and efficiently route the exhaust system is one of the biggest hurdles for any HVAC system designer. Noritz Common Venting offers designers the most flexibility to decide how to safely and efficiently route the vent. For room air installations, the combustion air can be drawn from the room environment, further reducing the installation complexity, by requiring only a single penetration for the exhaust.

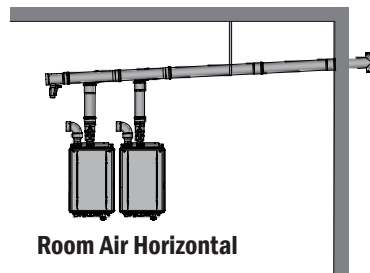
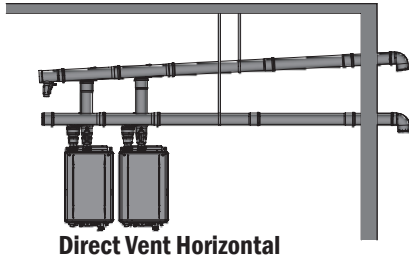
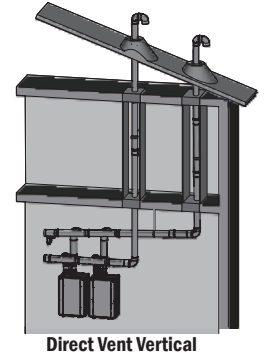
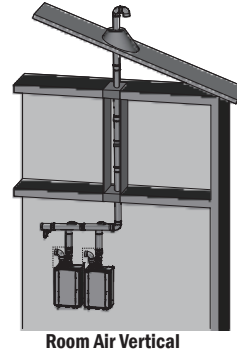
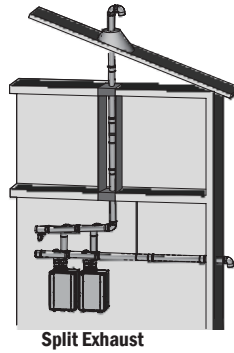

Table 1: Vent Diameter and Maximum Equivalent Vent Length

Model	Configuration	Number Of Units	Vent Diameter (in.) and Maximum Equivalent Vent Length (feet)							
			PVC or CPVC Schedule 40 Pipe				PP Vent			
			3"	4"	6"	8"	3"	4"	6"	8"
NCC199CDV (GQ-C3260WZ-FF US)	Both Direct Vent (DV) and Non-Direct Vent (SV)	2	18'	95'	200		18'	110'	200	
		3	N/A	39'	155'	200	N/A		155'	200
		4	N/A	N/A	90'	200	N/A	N/A	90'	200
		5	N/A	N/A	50'	150'	N/A	N/A	50'	150'
		6	N/A	N/A	35'	130'	N/A	N/A	35'	130'

The BTU/h input of the unit will be reduced by up to 9%

Note: The sizing method shown in Table 1 is provided for the convenience of the installer. Maximum acceptable vent system static pressure drop is 0.6" W.C.

**Table 2:
Equivalent Length
of Each Elbow**

Diameter of Elbow	Equivalent Length of Each Elbow (feet)			
	3"	4"	6"	8"
Length	5	12	18	20

Multi-Unit System Controller

- Each CR60 includes a pre-installed system controller (SC-401-6M).
- Each CR60 includes a pre-wired remote controller (RC-9018). Remote can be extended up to 300'
- User selectable temperature from 100-185°F



Basic Operation

The SC-401-6M system controller is used to combine 1-6 Noritz commercial heaters into a single “multi-unit system”. The system controller stages units on and off based on hot water demand and rotates their operation to ensure even usage. It also has two additional modes which optimize the system for operation with a recirculation line or storage tank.

Unit Staging

Staging allows the multi-unit system to track hot water demand from the minimum flow rate of a single unit up to the maximum output of several units. When the primary firing heater reaches approximately 50% of its maximum output, the system controller activates the next unit in the system. When both these units reach approximately 50% of their maximum output, a third unit is activated and so on. The SC-401-6M may also be configured to activate two heaters during primary firing to allow for rapid initial hot water demand.

Unit Rotation

The SC-401-6M system controller rotates operation of the primary firing heater every 8 hours of combustion time or up to 24 hours of plug-in time. This helps to ensure even usage of all units.

Unit 1	Unit 2	Unit 3	Unit 4	Unit 5	Unit 6
1st	2nd	3rd	4th	5th	6th
• Rotation					
6th	1st	2nd	3rd	4th	5th
• Rotation					
5th	6th	1st	2nd	3rd	4th
• Rotation					
4th	5th	6th	1st	2nd	3rd

The SC-401-6M allows the user to select two additional system types: “Recirc” and “Tank Recirc”. These settings optimize performance with recirculation and storage tank systems, and allow the system controller to operate one or two pumps.

<Recirc>

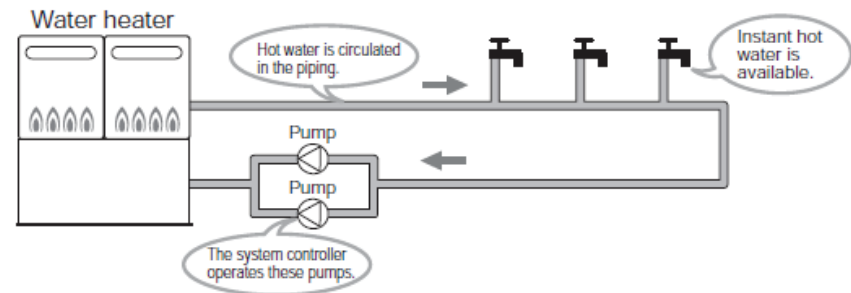

<Tank recirc>

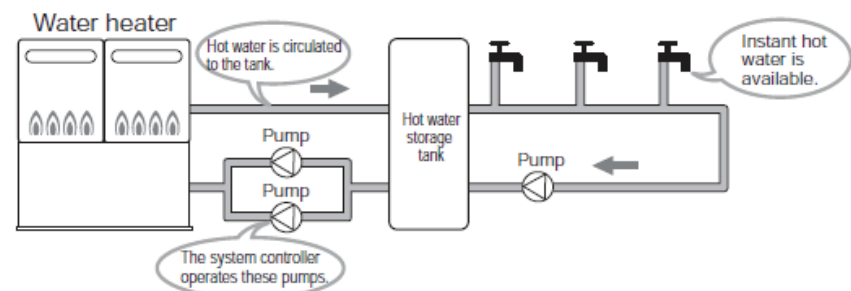

Included Accessories

Isolator Valve Kit

- Lead Free 3/4" threaded iso valve kit with male 500K Btuh Pressure Relief Valve

SC-#

System Controller

- SC-401-6M**
System controller for up to 6 units for the NCC199, NCC300 & NC380 series.

Optional Accessories

NT20A

Condensate Neutralizer Kit (External)

- NT20A¹**
Commercial condensate neutralizer kit for NC199, NCC199CDV, and NCC300 series
¹NT20A for commercial only

SC-#

System Controller

- SCU-401-12M-WIFI**
System controller bundle w/ NWCC adapter and System controller for NCC199CDV and NCC300 (12 units)
- SCU-401-24M-WIFI**
System controller bundle w/ NWCC Adapter and System Controller for NCC199CDV (24 units)

VC-6-1

Outdoor Vent Cap

- VC-6-1**
Outdoor vent cap for EZ, NRCR, and CDV models.

SV-CK-2-1

DV to SV Conversion Kit

- SV-CK-2-1**
2" PVC (EZ / CDV)

PVC-#CT

PVC Concentric Horizontal Termination Kit

- PVC-2CT**
2" PVC Concentric Termination
- PVC-3CT**
3" PVC Concentric Termination

PRC-1

Plastic Rain Cap

- PRC-1**
2" (EZ98, EZ111, NCC199CDV)
- 3" (For NRC111, NCC199, NRC98, NRC71, NRC66, NRCB, & NCC199CDV)
- 4" (For NRC111, NCC199, NRC98, NCC300)

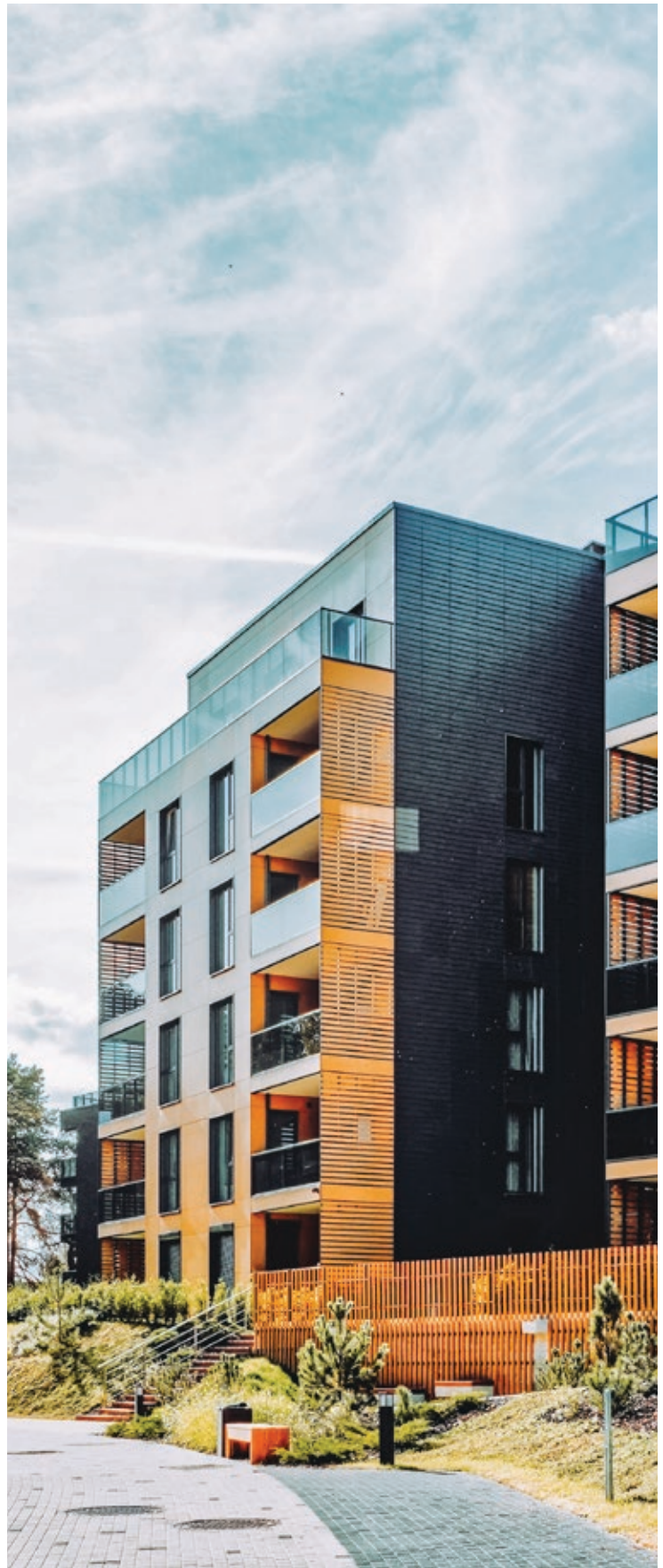

CR60-WH-2

Plumbing Diagrams - Storage Recirculation

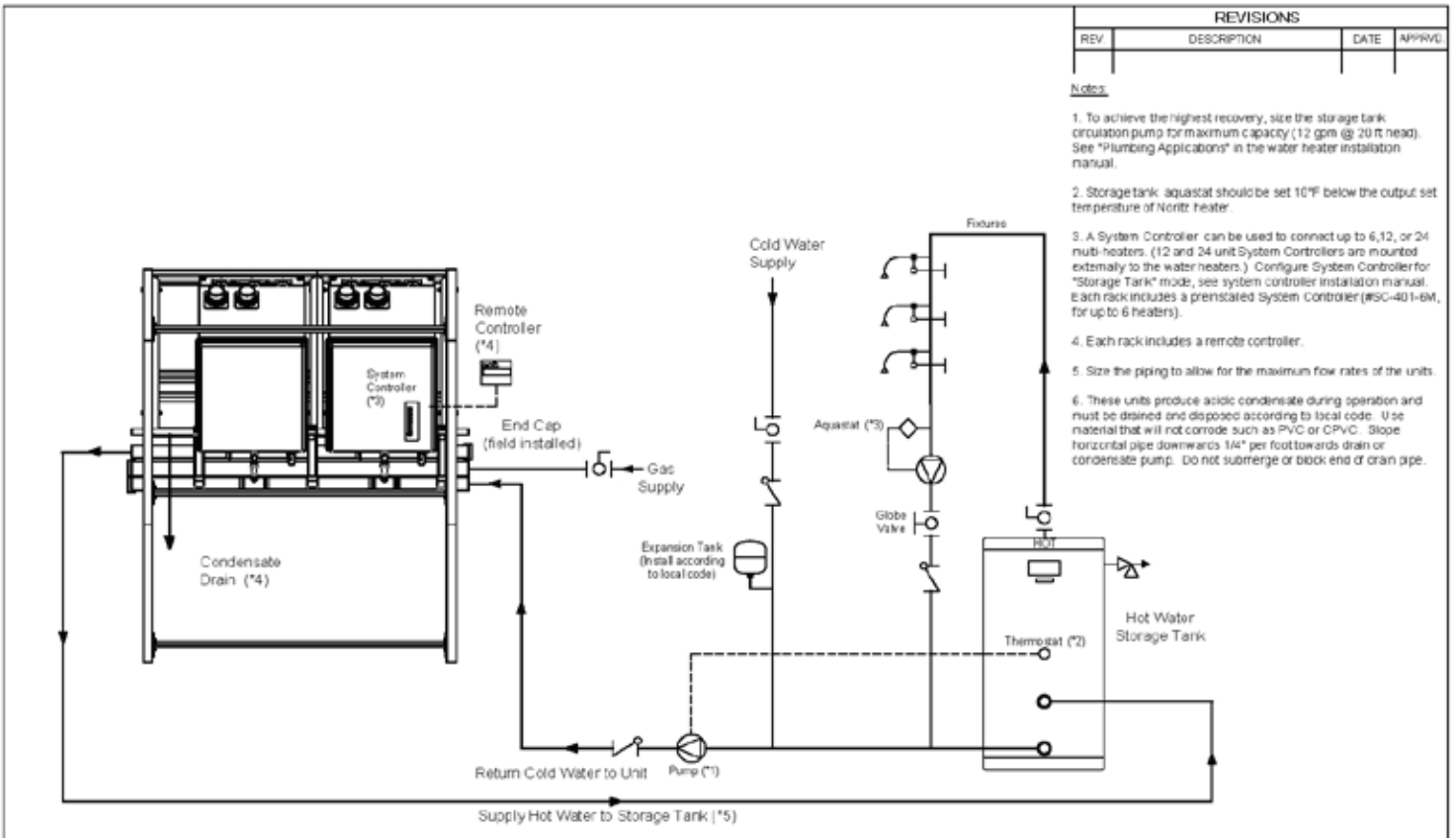

REVISIONS			
REV	DESCRIPTION	DATE	APPROV

- Notes:
- To achieve the highest recovery, size the storage tank circulation pump for maximum capacity (12 gpm @ 20 ft head). See "Plumbing Applications" in the water heater installation manual.
 - Storage tank aquastat should be set 10°F below the output set temperature of Noritz heater.
 - A System Controller can be used to connect up to 6, 12, or 24 multi-heaters. (12 and 24 unit System Controllers are mounted externally to the water heaters.) Configure System Controller for "Storage Tank" mode, see system controller installation manual. Each rack includes a pre-installed System Controller (#SC-401-6M, for up to 6 heaters).
 - Each rack includes a remote controller.
 - Size the piping to allow for the maximum flow rates of the units.
 - These units produce acidic condensate during operation and must be drained and disposed according to local code. Use material that will not corrode such as PVC or CPVC. Slope horizontal pipe downwards 1/4" per foot towards drain or condensate pump. Do not submerge or block end of drain pipe.

<p>11100 Grace Avenue Fountain Valley, California 92708 866-7NORITZ (866-768-7489) www.noritz.com</p>	MODEL: CR60-WH-2-NG CR60-WH-2-LP	Noritz Accessories Outdoor Vent Cap (# VC-6) Commercial WiFi Adapter (# NWCC-ADAPTER) Commercial Neutralizer (# NT-20A)	<i>Note: This diagram is for reference only. Installation must comply with State and Local Code, all gas and water pipe must be sized correctly to specific length, according to accepted engineering methods or the UPC Code for Noritz Water Heaters to operate correctly.</i>	
	APPLICATION: Domestic Hot Water Recirculation Multi-System Storage Tank	Shut-off Ball Valve Check Valve Union Pressure Relief Valve (Watts 174A, Zurn P3000BR, Cash Acme F-82)	Aquastat (Honeywell Model #L6006A or L6006C) Pump Mixing Valve Thermal Expansion Tank	
	DRAWING NUMBER: CR-2-ST-REC			
	DRAWING DATE: April 2020			

CR60-WH-2

Plumbing Diagrams - No Storage Recirculation

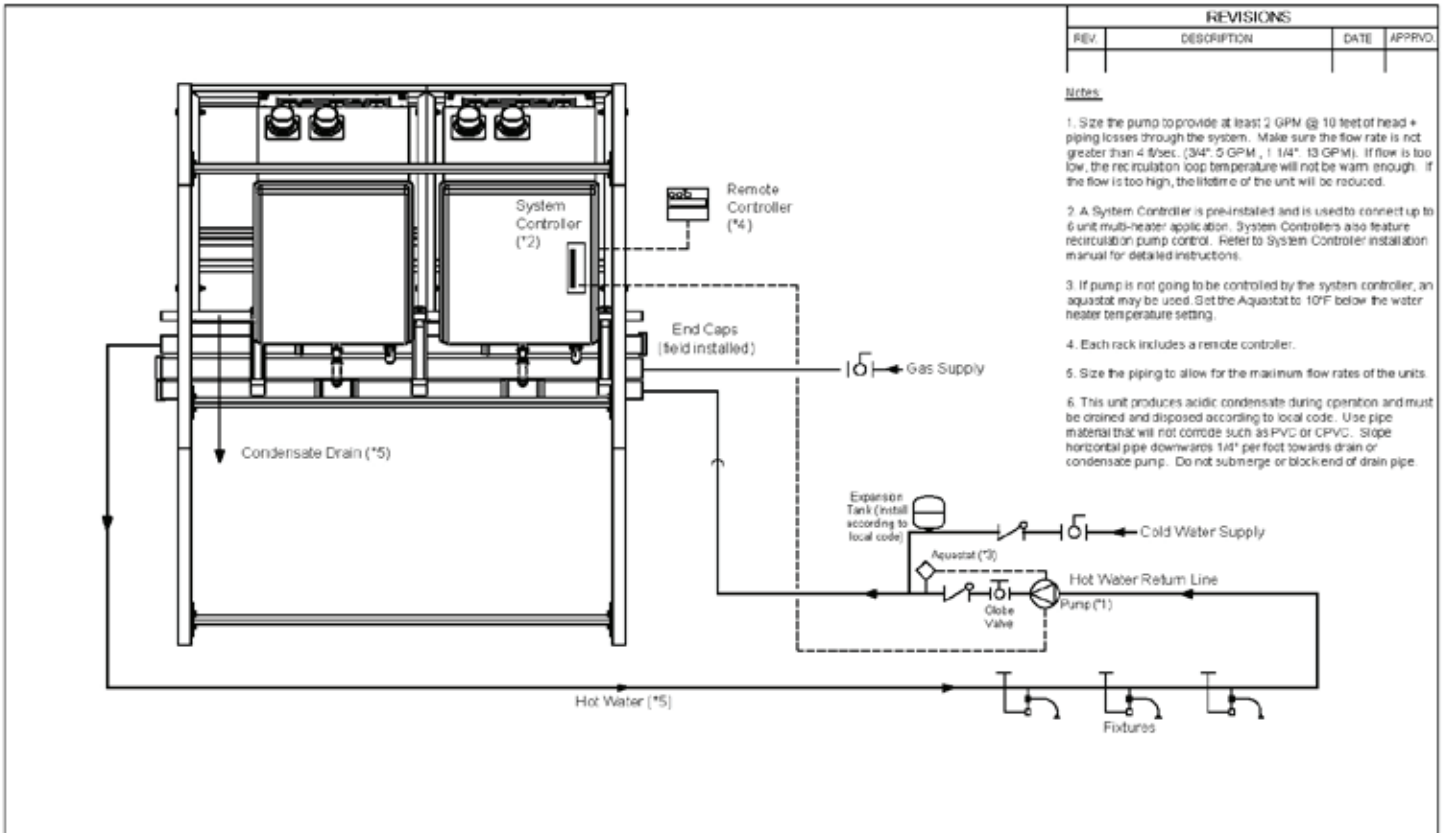

REVISIONS			
REV.	DESCRIPTION	DATE	APPROV.

- Notes**
1. Size the pump to provide at least 2 GPM @ 10 feet of head + piping losses through the system. Make sure the flow rate is not greater than 4 ft/sec. (3/4" 5 GPM, 1 1/4" 13 GPM). If flow is too low, the recirculation loop temperature will not be warm enough. If the flow is too high, the lifetime of the unit will be reduced.
 2. A System Controller is pre-installed and is used to connect up to 6 unit multi-heater application. System Controllers also feature recirculation pump control. Refer to System Controller installation manual for detailed instructions.
 3. If pump is not going to be controlled by the system controller, an aquastat may be used. Set the Aquastat to 10°F below the water heater temperature setting.
 4. Each rack includes a remote controller.
 5. Size the piping to allow for the maximum flow rates of the units.
 6. This unit produces acidic condensate during operation and must be drained and disposed according to local code. Use pipe material that will not corrode such as PVC or CPVC. Slope horizontal pipe downwards 1/4" per foot towards drain or condensate pump. Do not submerge or block end of drain pipe.

<p>11190 Grace Avenue Fountain Valley, California 92708 866-7NORITZ (866-736-7489) www.noritz.com</p>	MODEL: CR60-WH-2 (NG OR LP)	Noritz Accessories Outdoor Vent Cap (#VC-6) Commercial WiFi Adapter (#NWCC-ADAPTER) Commercial Neutralizer (#NT-20A)	<i>Note: This diagram is for reference only. Installation must comply with State and Local Code, all gas and water pipe must be sized correctly to specific length, according to accepted engineering methods or the UPC Code for Noritz Water Heaters to operate correctly.</i>	
	APPLICATION: Domestic Hot Water Multi-System Rack Recirculation	DRAWING NUMBER: CR2-RECIRC	Shut-off Ball Valve Check Valve Union Pressure Relief Valve (Watts 174A, Zurn P3000BR, Cash Acme F-82)	Aquastat (Honeywell Model #L6006A or L6006C) Pump Mixing Valve Thermal Expansion Tank
	DRAWING DATE: June 2020			



Commercial Consultation

Schedule a call with one of our commercial experts

Have a question on specs, sizing, or how you can build Noritz into your next project? Talk to our commercial experts directly at Commercial@Noritz.com

Technical Support

Noritz America provides two customer-service initiatives:

- A Technical Support Website
- An In-House Call Center with the goal of delivering information more quickly and efficiently to customers, whether their preferred method is the telephone or online.

To speak to one of our Tech Support Professionals:

866-766-7489 (Press 1)

Visit our Technical Support Site at:

Support.Noritz.com



11160 Grace Avenue
Fountain Valley, CA 92708

Phone:

1-866-766-7489

Tech Support Hours:

Monday - Friday

5am - 6pm PST

Sat-Sun

7am - 4pm PST

Fax:

(714) 241-1514

Affiliations

